



自衛隊
のりもの
シリーズ

ブロックで
簡単組立

砲塔が旋回、
砲身が可動

発射パーツ
つき

組立説明書 &
シールつき

対象年齢
6歳以上

楽しい!!
可動ギミック → 130パーツのブロックでつくる!

陸上自衛隊 16式機動戦闘車

を組み立てよう!



ちょっとかわいい

組立説明書

1

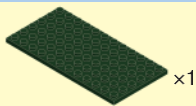

ここで組み立てるのに必要なブロックのリストです。組み立てる前に必要なブロックをそろえてから組み立てよう！

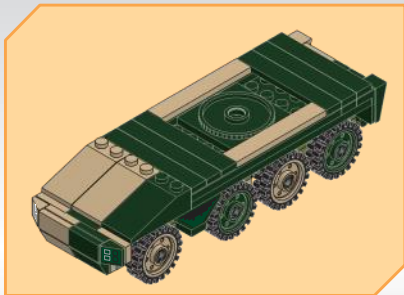

まずはこの形を目指して組み立ててください。

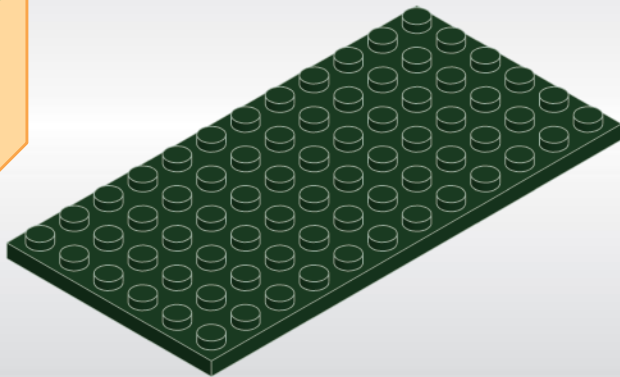

1

2

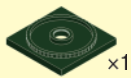

x1

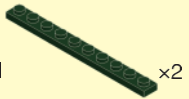

x2

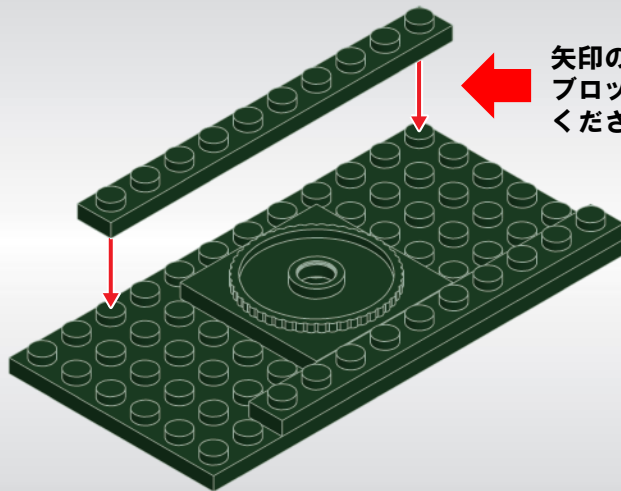

矢印の位置を確認して
ブロックを取り付けて
ください。

2

3

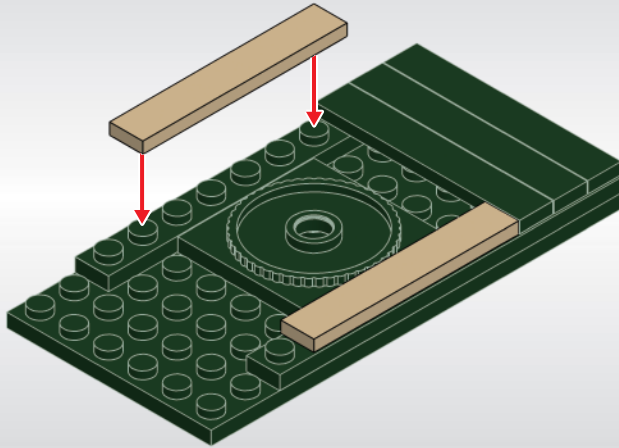
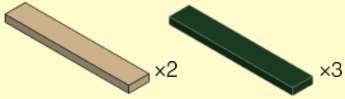

3

4



x2



x1

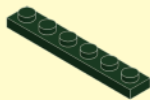

x1

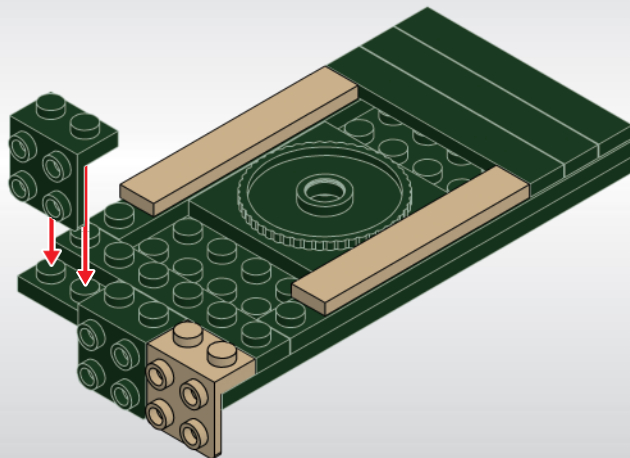

4

5

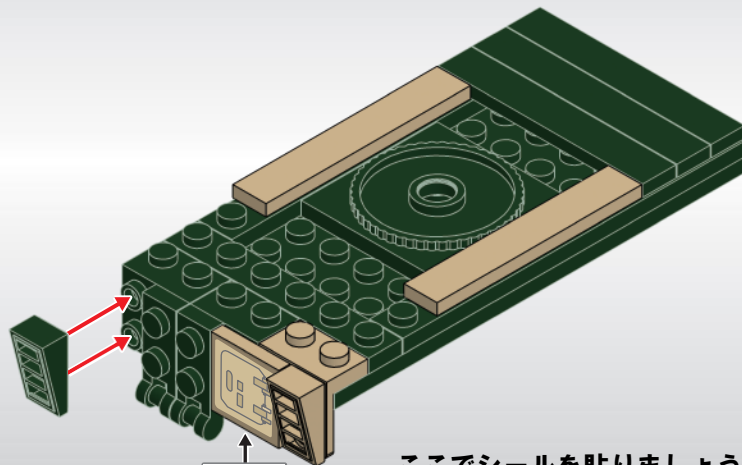

ここでシールを貼りましょう！
番号を間違えないように位置を確認しながら貼ってください。

5

6

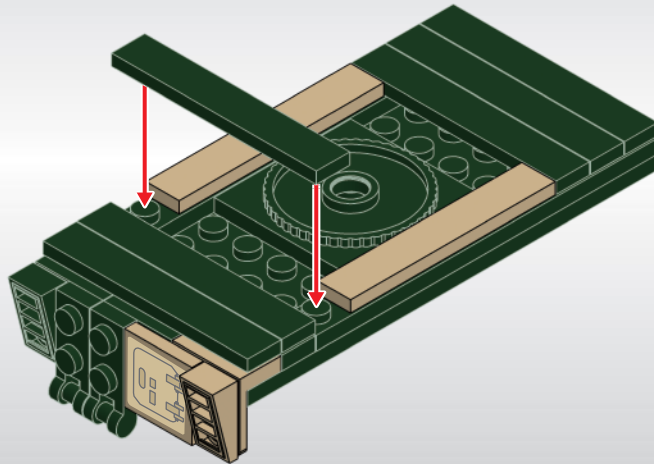
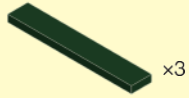

6

7

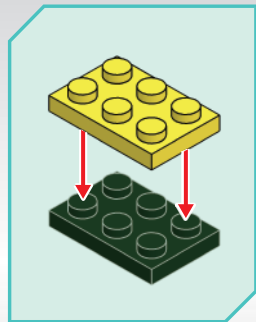
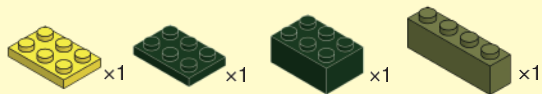

小窓から組み立て
てください。

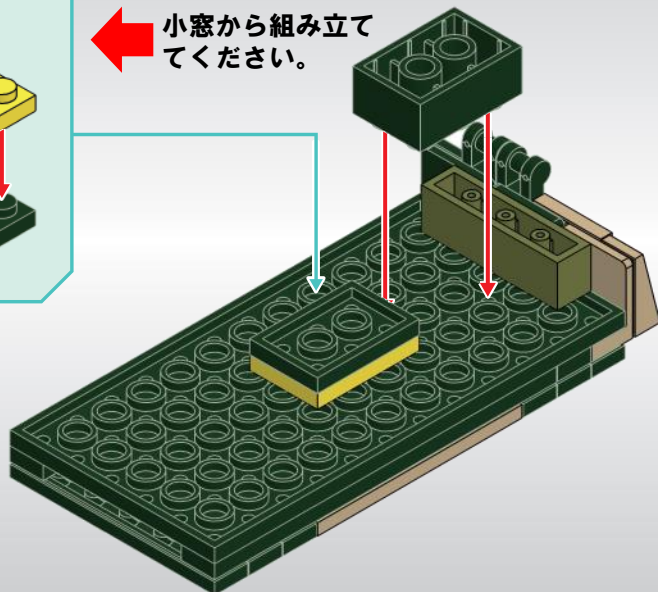

位置を変えるアイコンです。
組立番号6で完成したブロックを
裏返して組み立ててください。

7

8

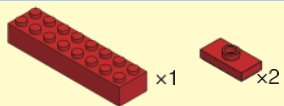

間違いやすいパーツです。
確認して取り付けて下さい。

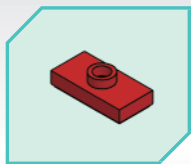

このブロックを
2個取り付けます。

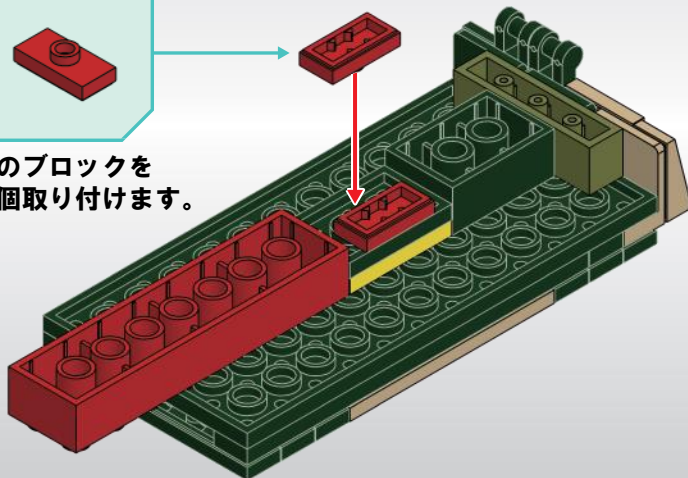

8

9

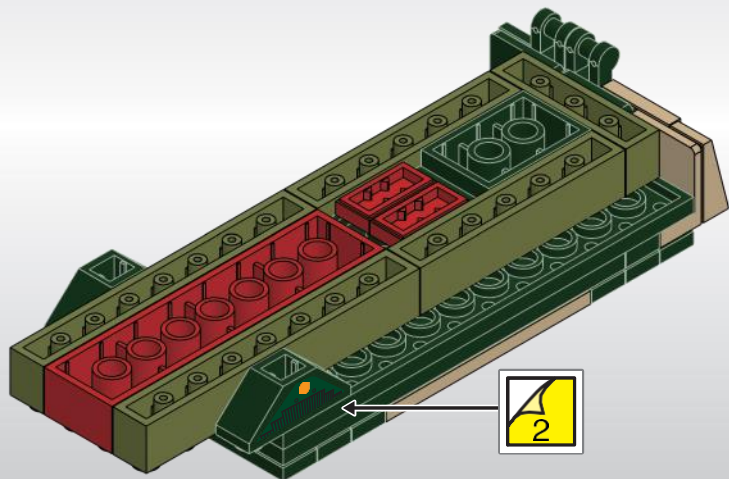
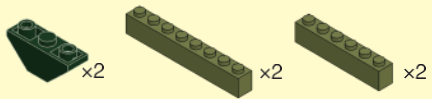

9

10



x2



x2

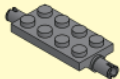

x3

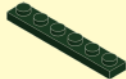

x1

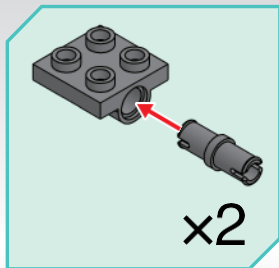

x2

同じパーツを
2個組み立て
ます。

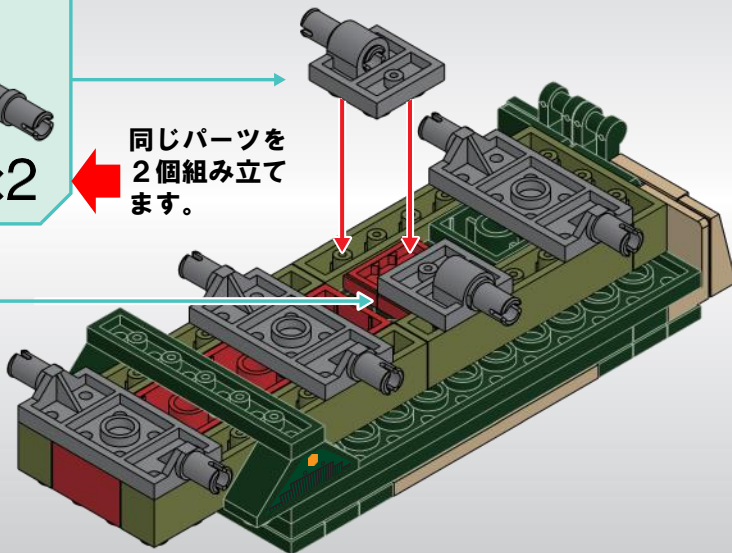

10

11

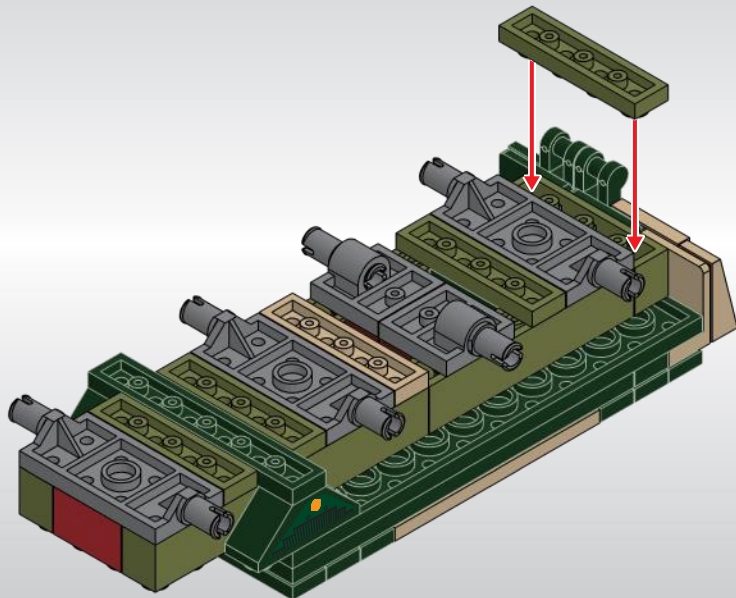
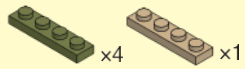

11

12

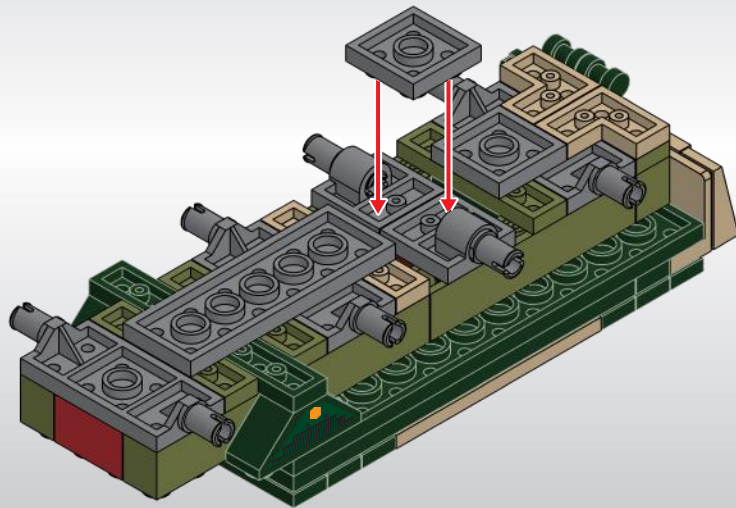
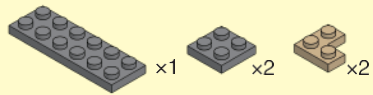

12

13

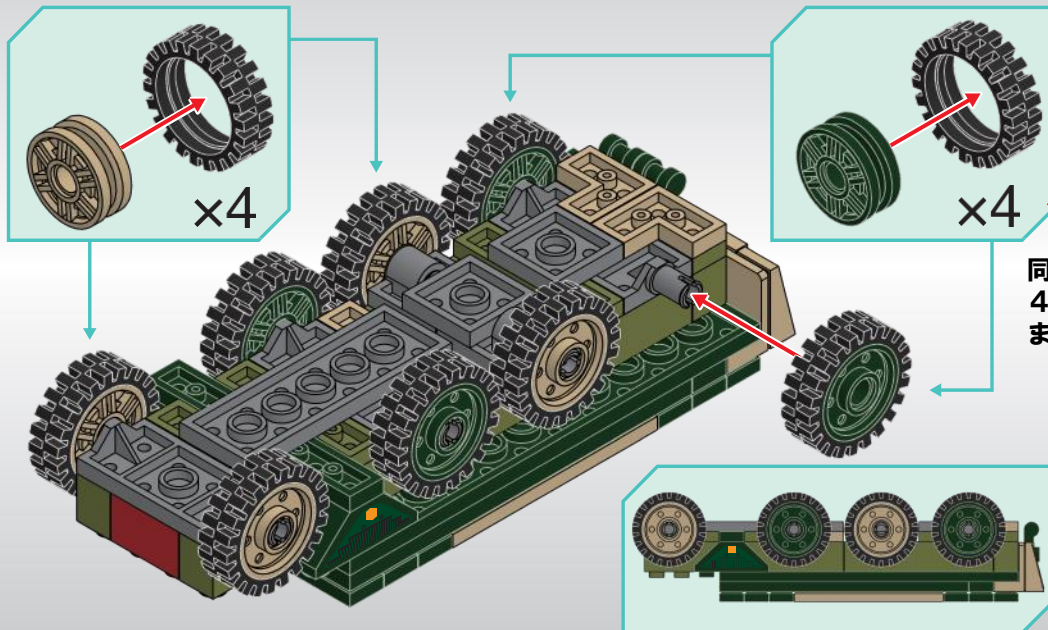

同じパーツを
4個組み立て
ます。

13

取り付ける位置を確認してください。

14

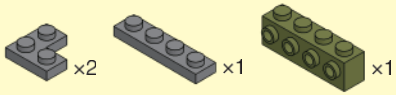

1

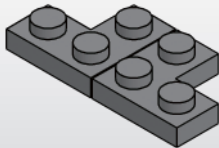

2

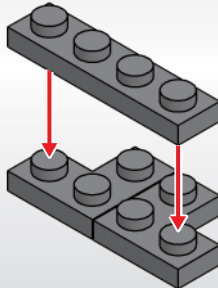

3

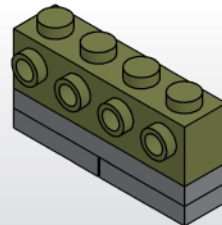

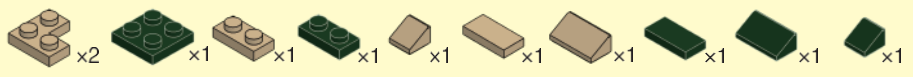

1

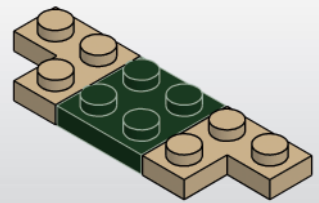

2

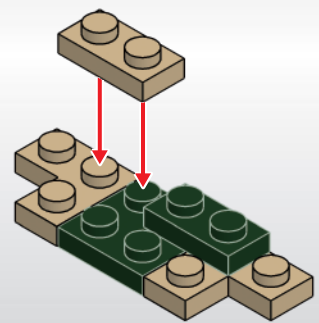

3

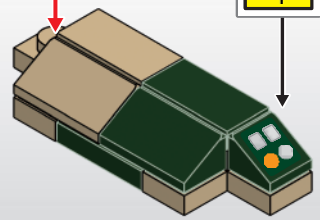

16

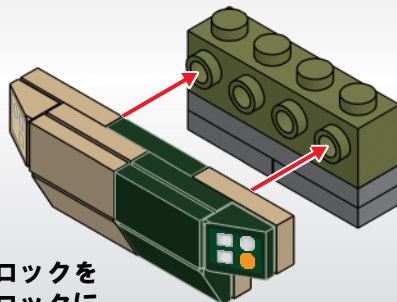

組立番号15で完成したブロックを
組立番号14で完成したブロックに
取り付けてください。

16

17

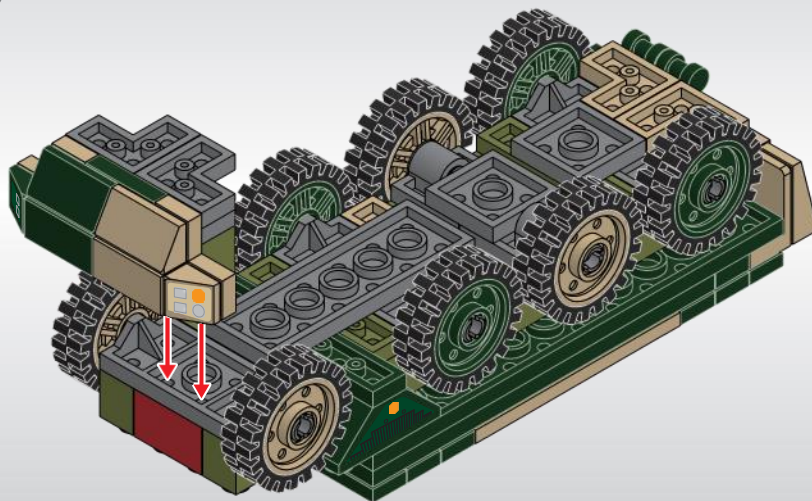
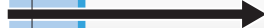

17

18

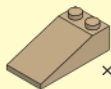

x2



x1

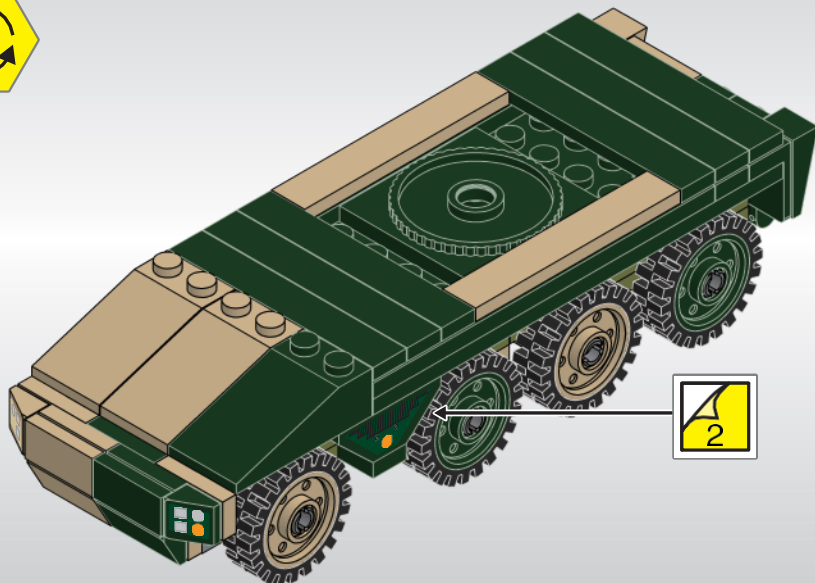

18

19

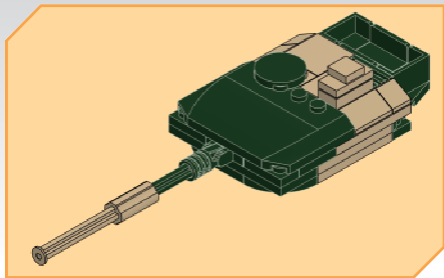

砲塔を組み立てます。

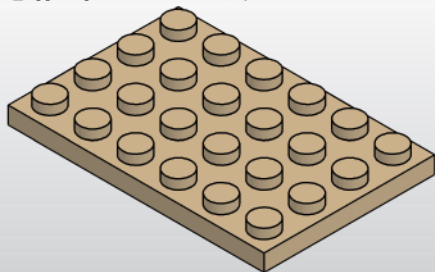

19

20

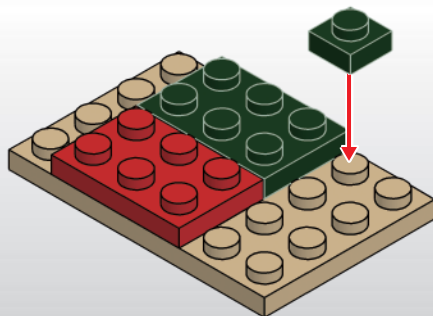
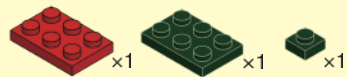

21

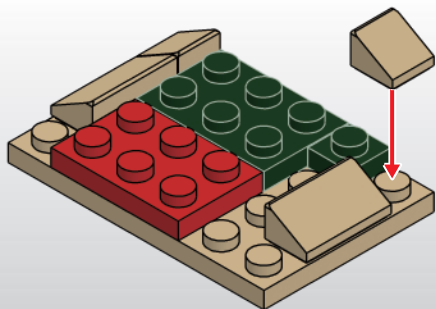
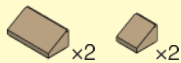

22

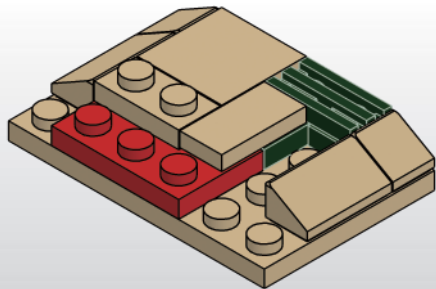
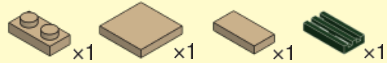

20

23

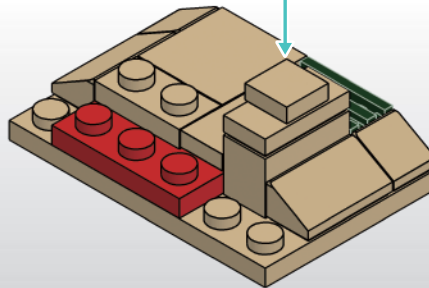
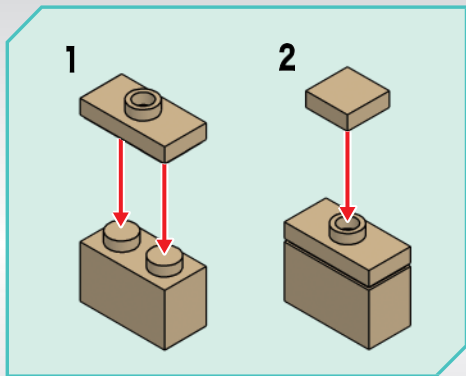

21

24

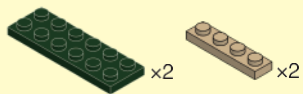

1

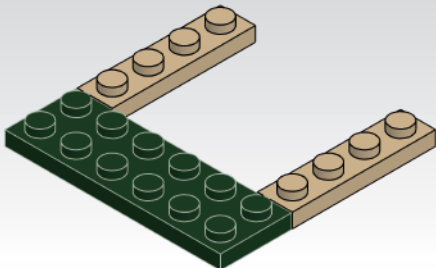

2

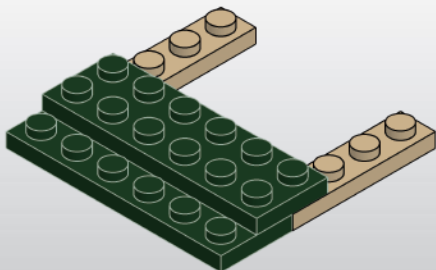

3

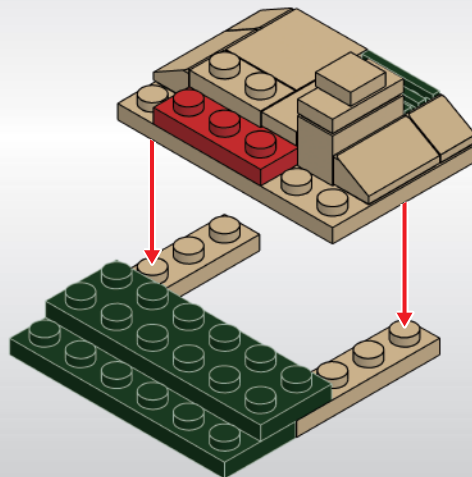

22

25



x1



x1



x1



x1

1

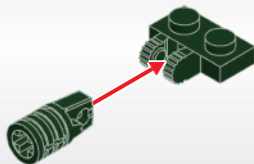

2

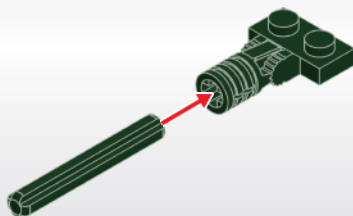

3

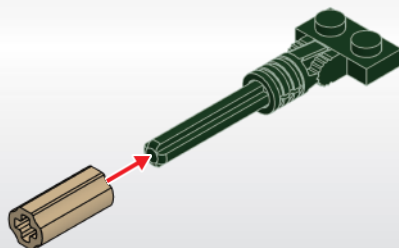

1:1



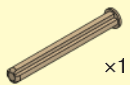

26

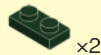

4

1:1

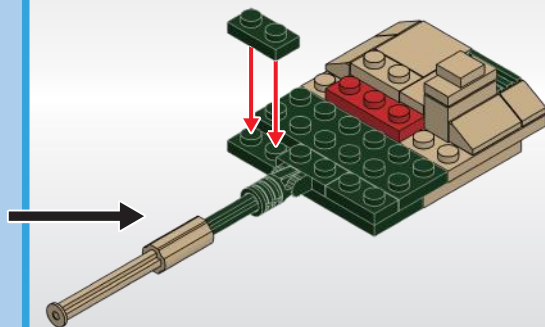
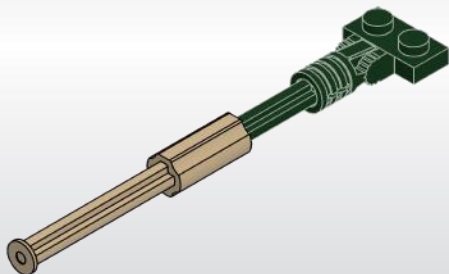

24

27

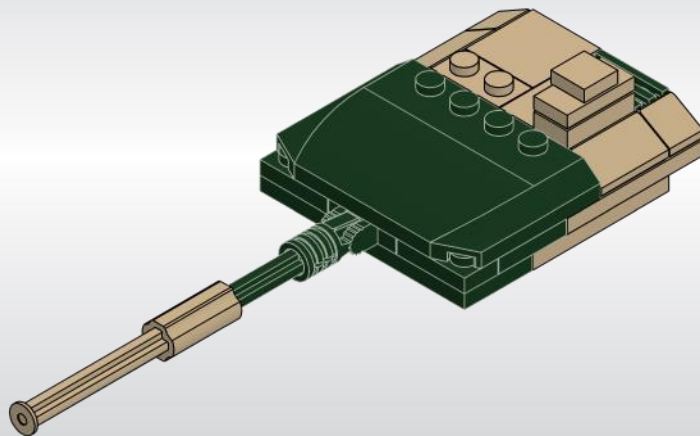
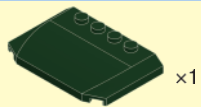

25

28

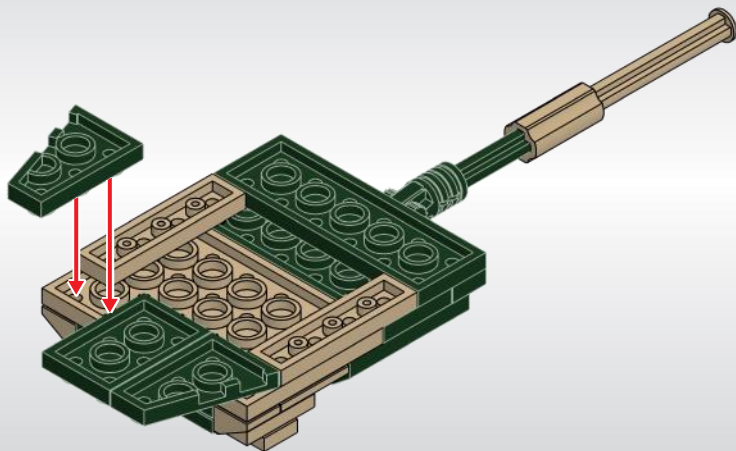
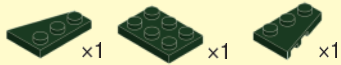

26

29

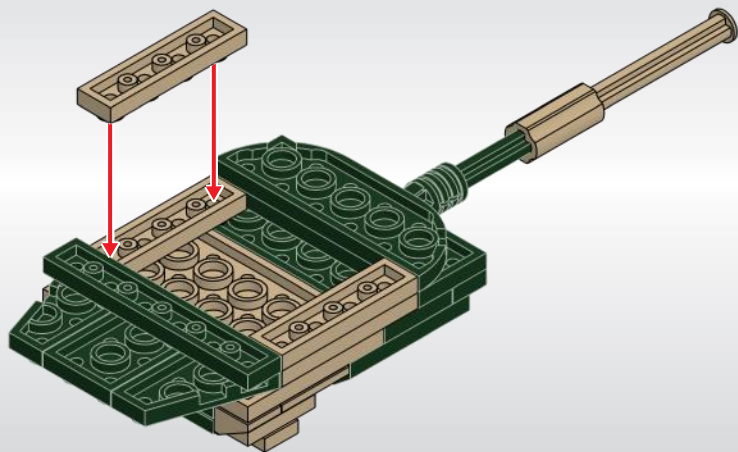
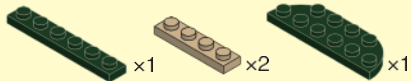

27

30

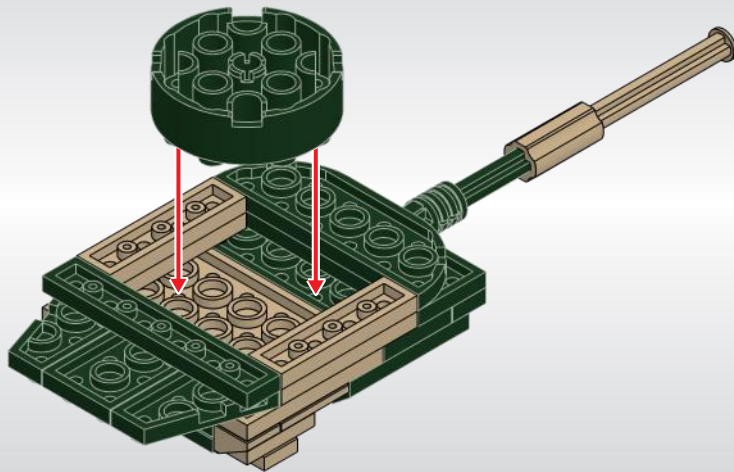

31

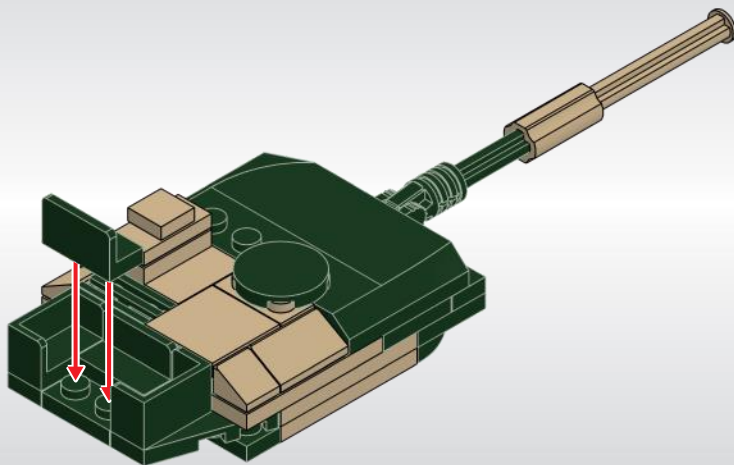
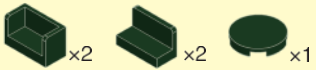

32

組立番号31で完成したブロックを
組立番号18で完成したブロックに
取り付けてください。

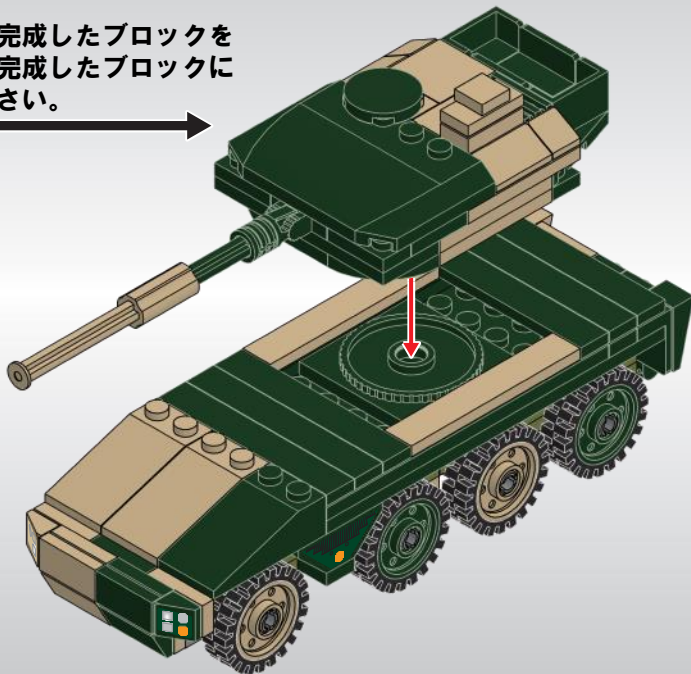

33

16式機動戦闘車完成！

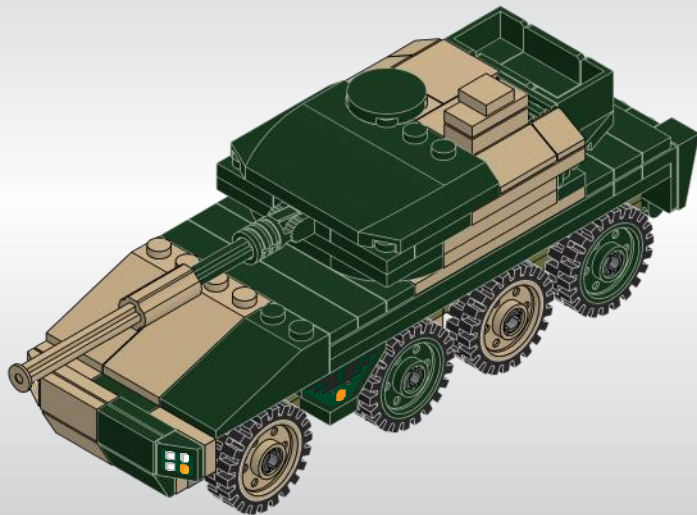

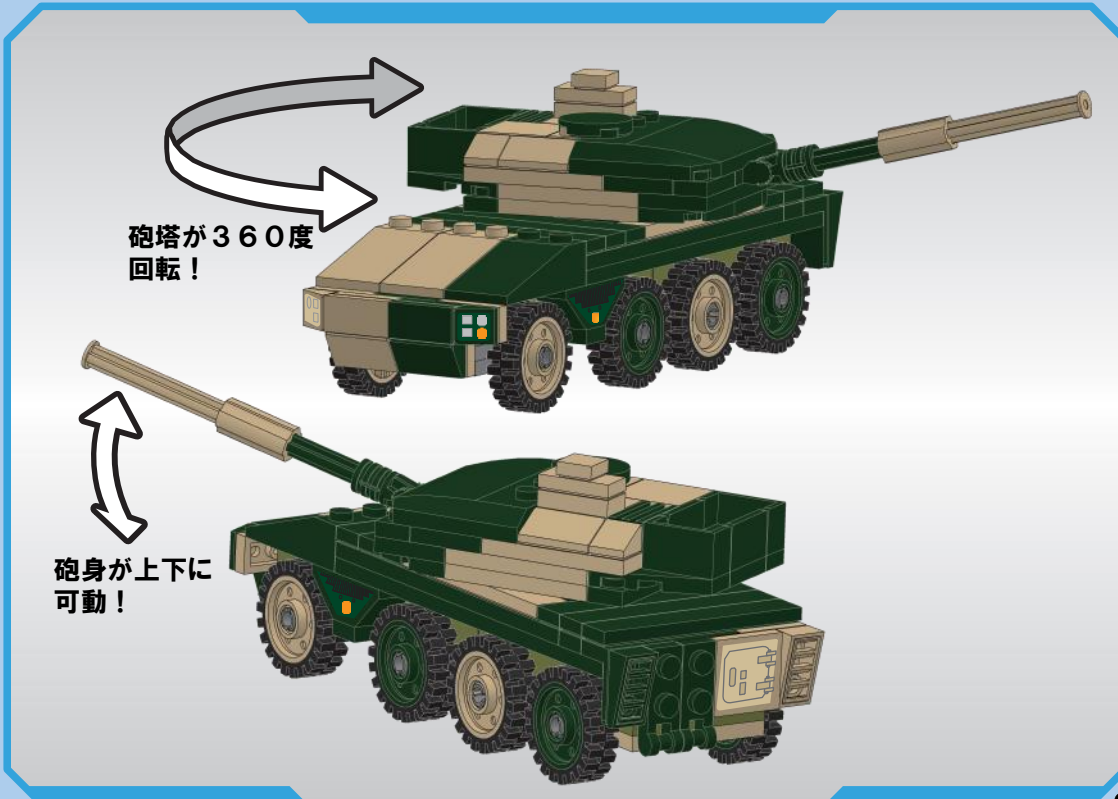

砲塔が360度
回転!

The image shows two views of a green and tan LEGO tank model. The top view shows the tank from a three-quarter perspective, with a large curved arrow indicating the turret's 360-degree rotation. The bottom view shows the tank from a rear-quarter perspective, with a curved arrow indicating the vertical movement of the main gun barrel.

砲身が上下に
可動!

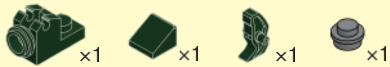

注意

- 発射する部品は目や顔に向けてはいけません。
- 発射パーツは人や動物に向けて絶対に飛ばさないでください。

発射パーツを取り付けます（任意）

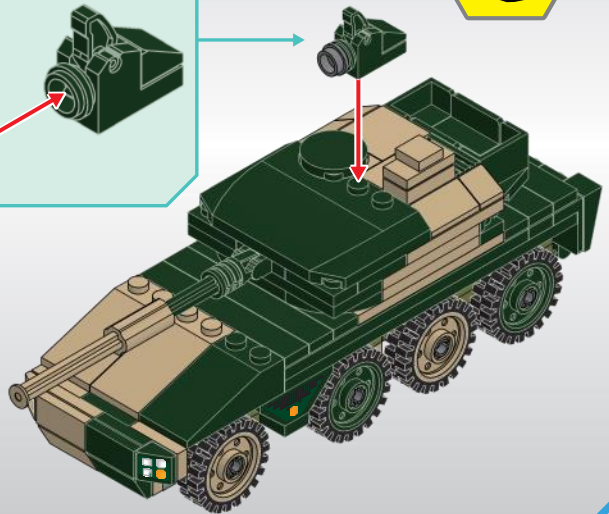
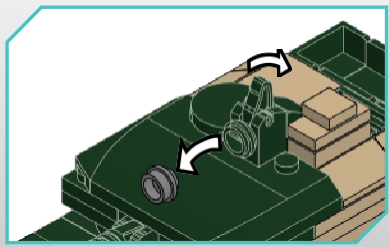
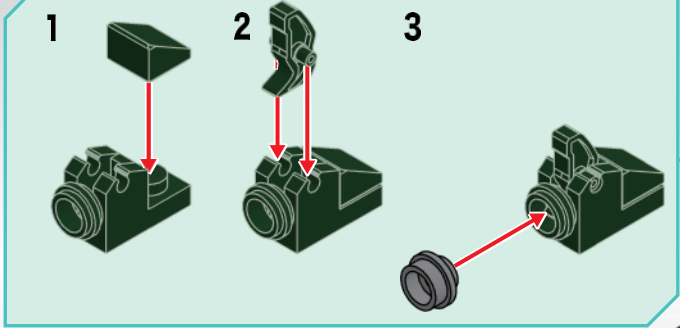

ブロックのパーツリストです。

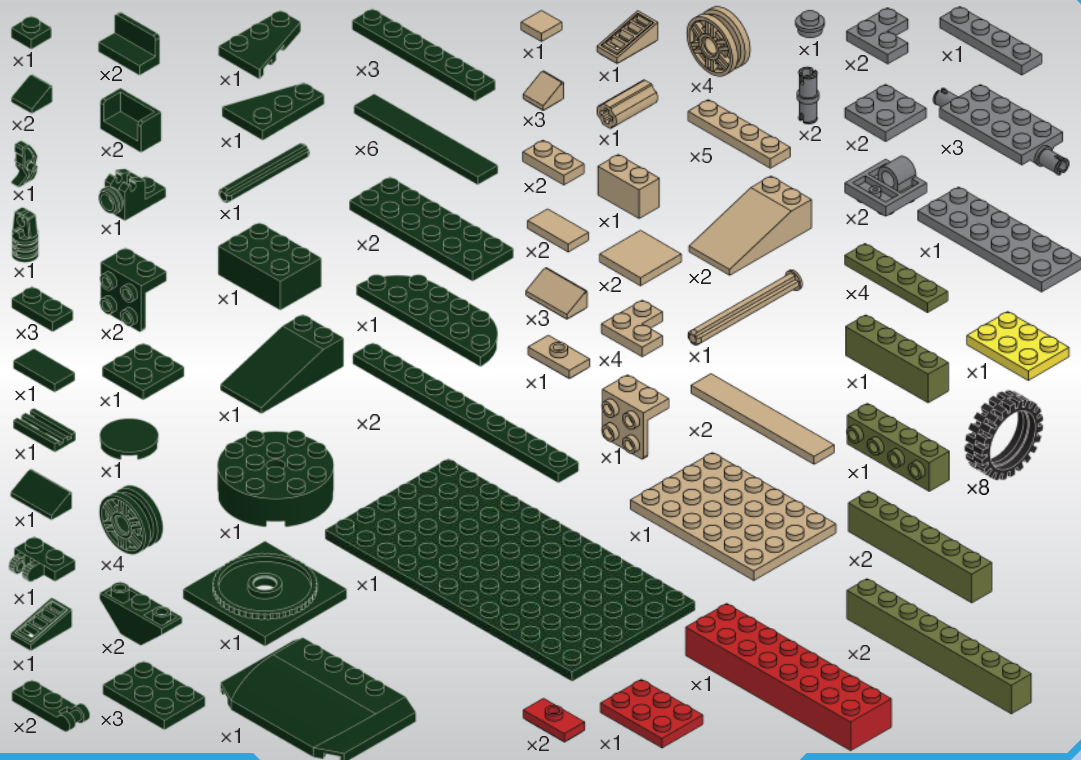

※ブロックは多めに入っています。