

まずは1の袋を開けましょう！  
(2の袋はまだ開けないでください)



1の袋で下のイラストの  
形が組み立てられます ↓



最初に人形（チャーリー）  
を組み立てよう！

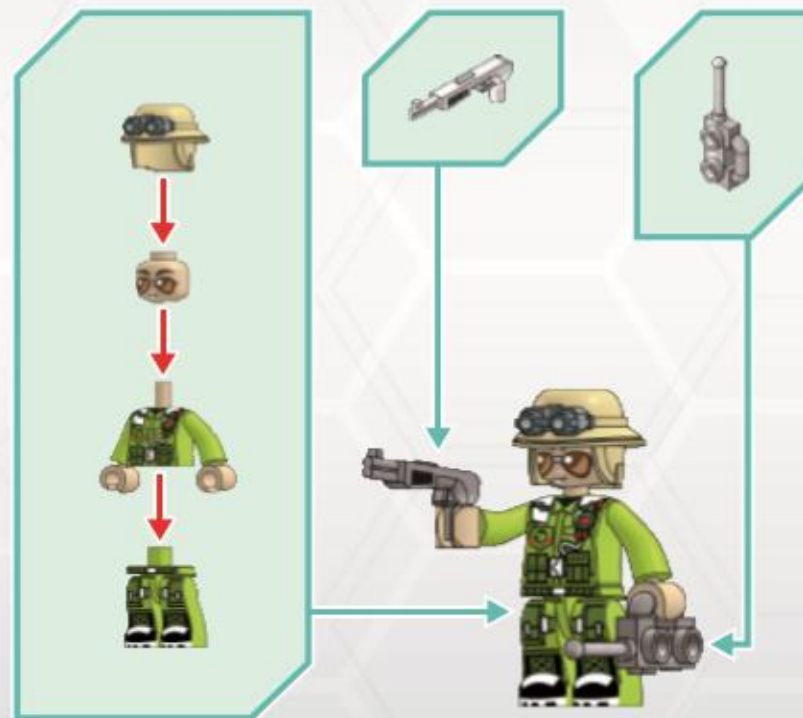

武器・通信機は手に持たせられます

1

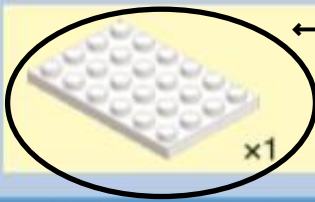

←使用するブロックはここに  
イラストが書いてあるので、  
それをさがしながら組み  
立てていきましょう！

↑上の組立番号順に組み立ててください



←まずはこの形を  
組んでいきます

2



x1



x2

組立説明のイラストを見ながら、  
組み立ててください



3



x1

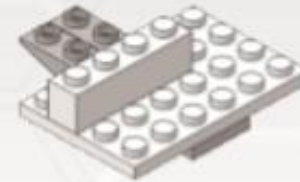

4



x1



2

5



7



↑この黄色い数字はシールを貼るマークです。  
シールの番号と貼る位置を確認して貼ってください

6



8



↑この黄色い矢印は位置を変えるマークです。  
ひとつ前の説明のブロックの位置を変えて組み立ててください

↑上の小窓は組み忘れしそうなパーツなのでイラストを見て取り付けてください

3

9

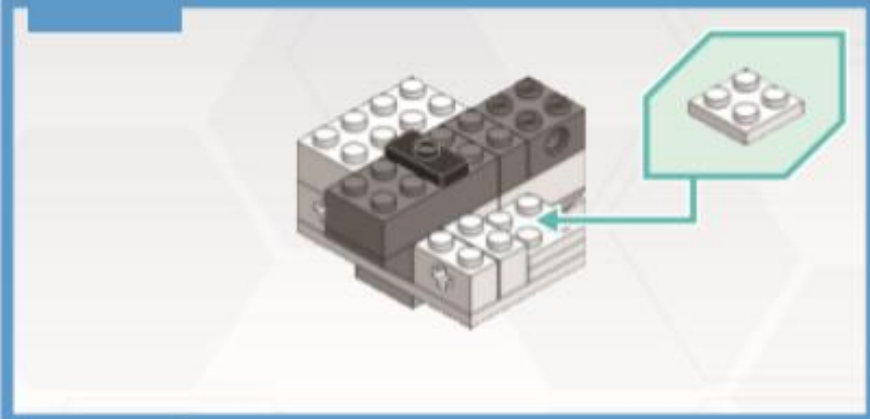

11

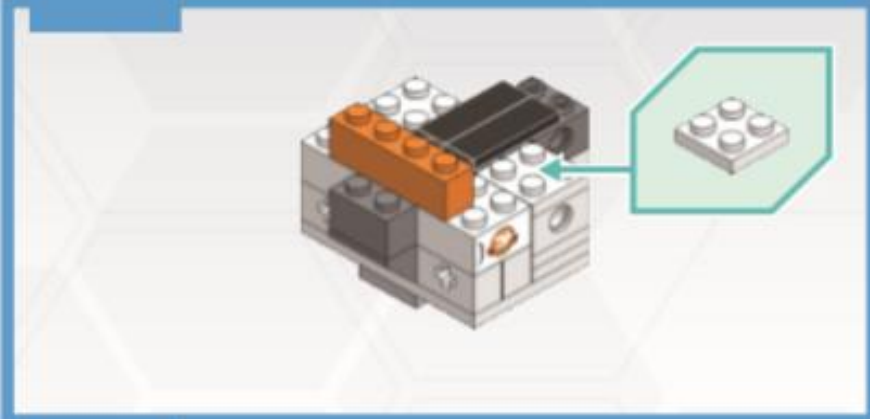

10

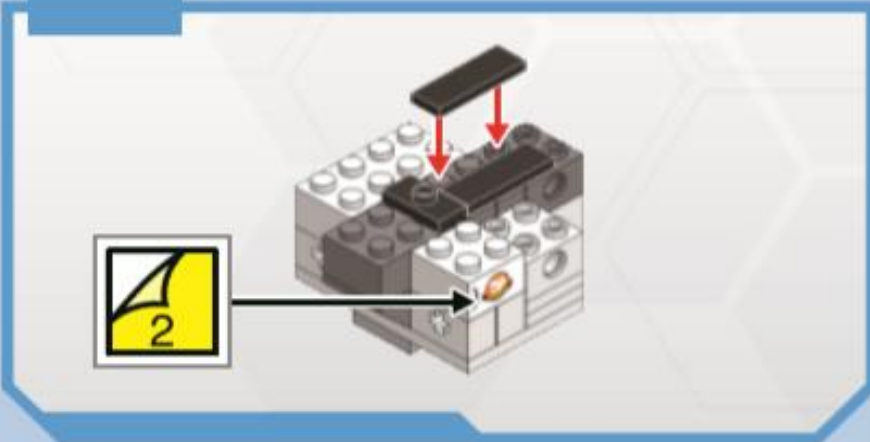

12



13

x2 x1

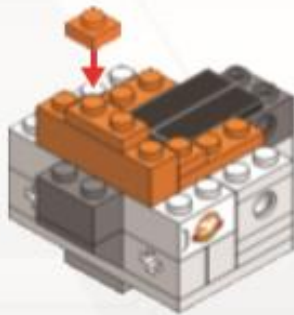

14

x2 x2



15

x4



5

# 16

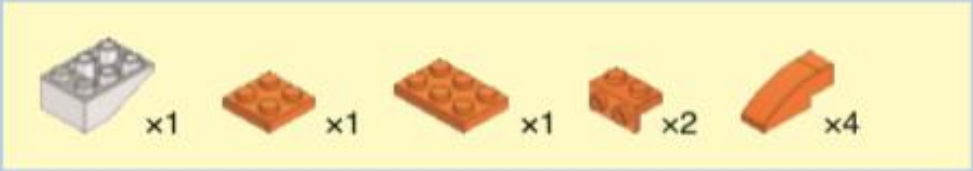

↓別に説明の枠がある場合は先にそれを組み立ててから、ブロックに取り付けてください

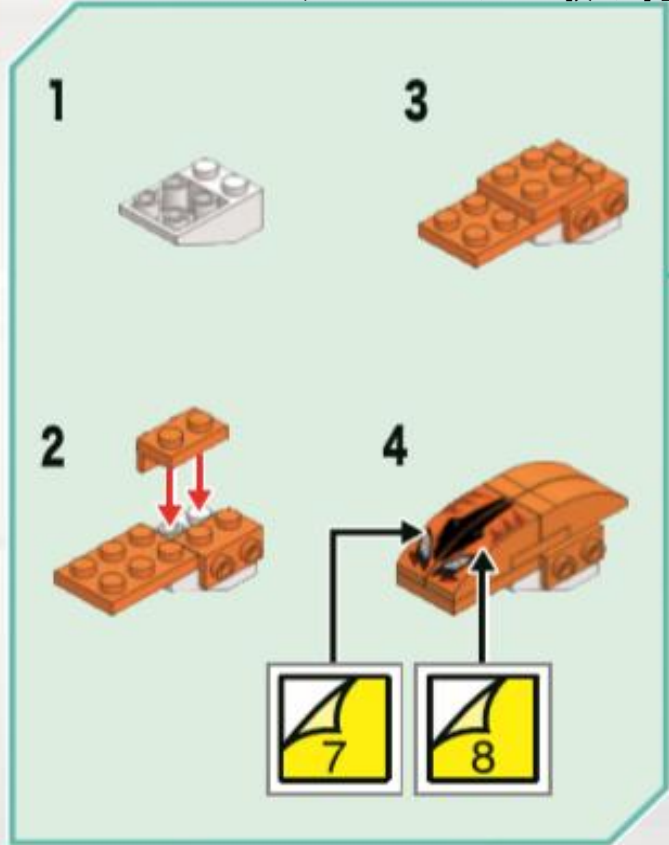

# 17

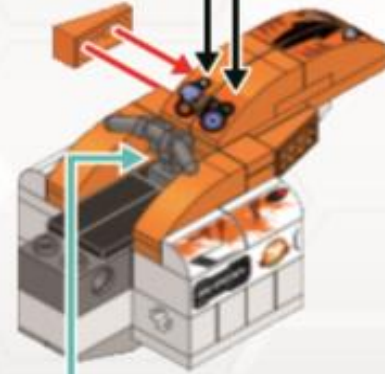

# 6

18

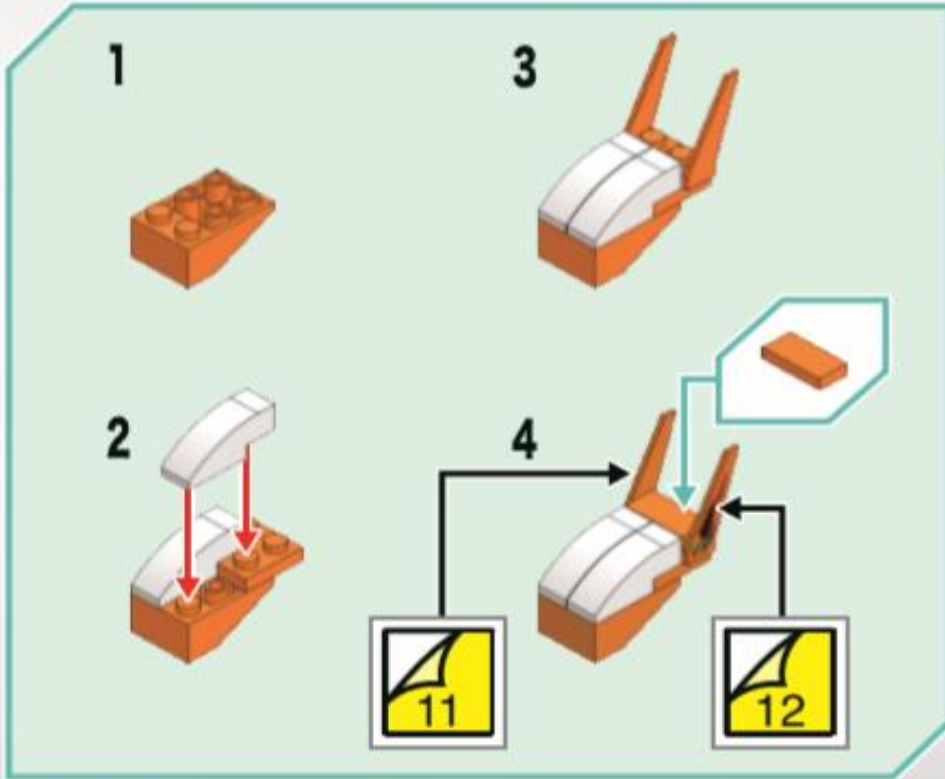

7

# 19



ここで2の袋を開けましょう！



下のイラスト  
の形が  
完成します！

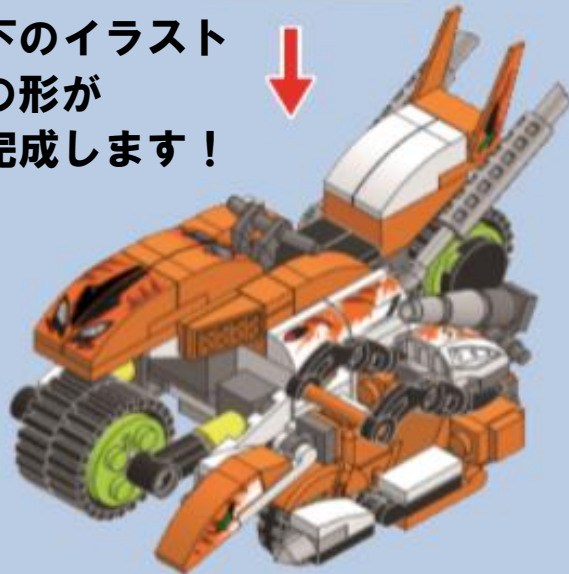

↓同じ長さの棒（十字の棒）をさがして  
組み立ててください





# 20

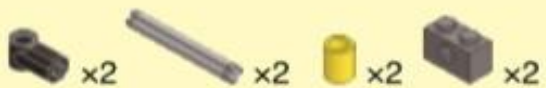

1



3



2



4



x2

「×2」と書いてあったら、  
同じ形を2セット組み立てます

# 21

組立番号21番では新しく使う  
パーツはありません。

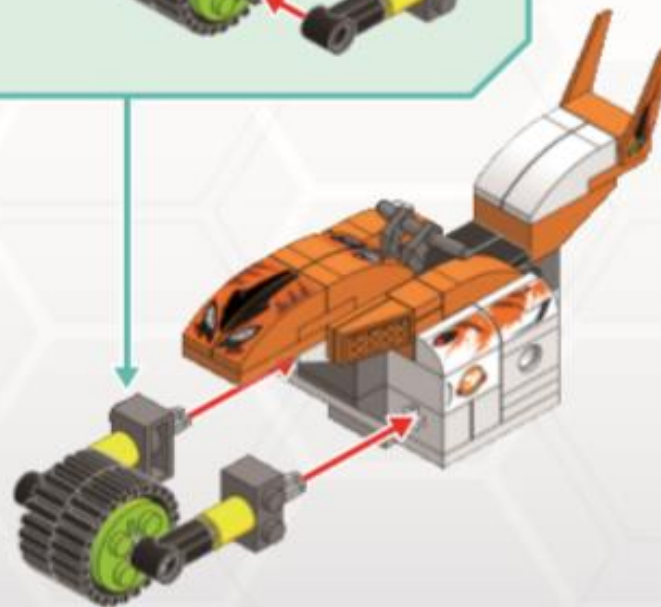
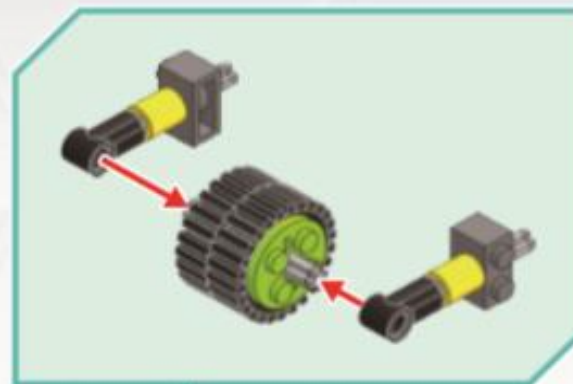

# 22



1



2



3



4



5



1:1

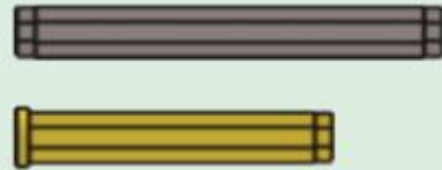

10

23



24



ここからはサイドカー  
 (ダイノラプター)  
 を組み立てていきます

25

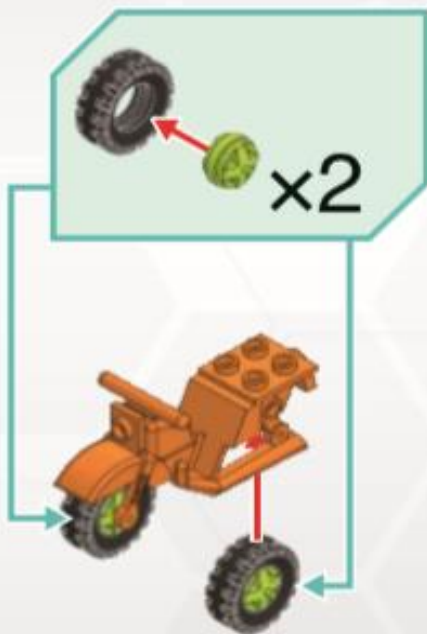

26



27

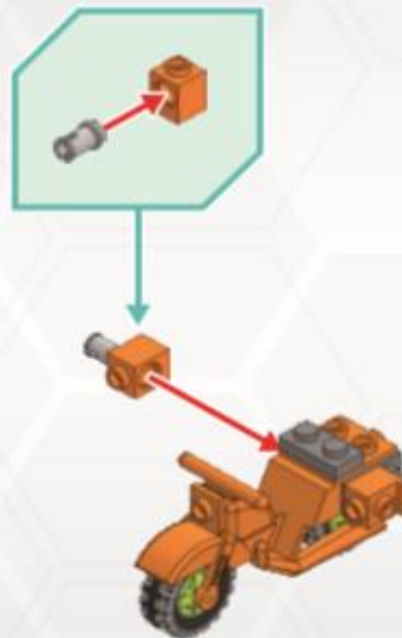
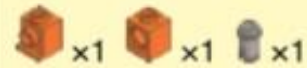

28



29

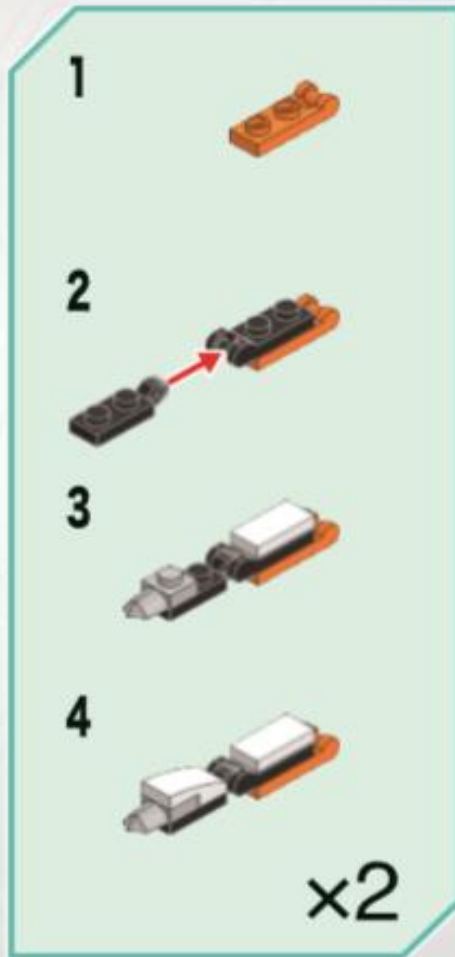

13

30

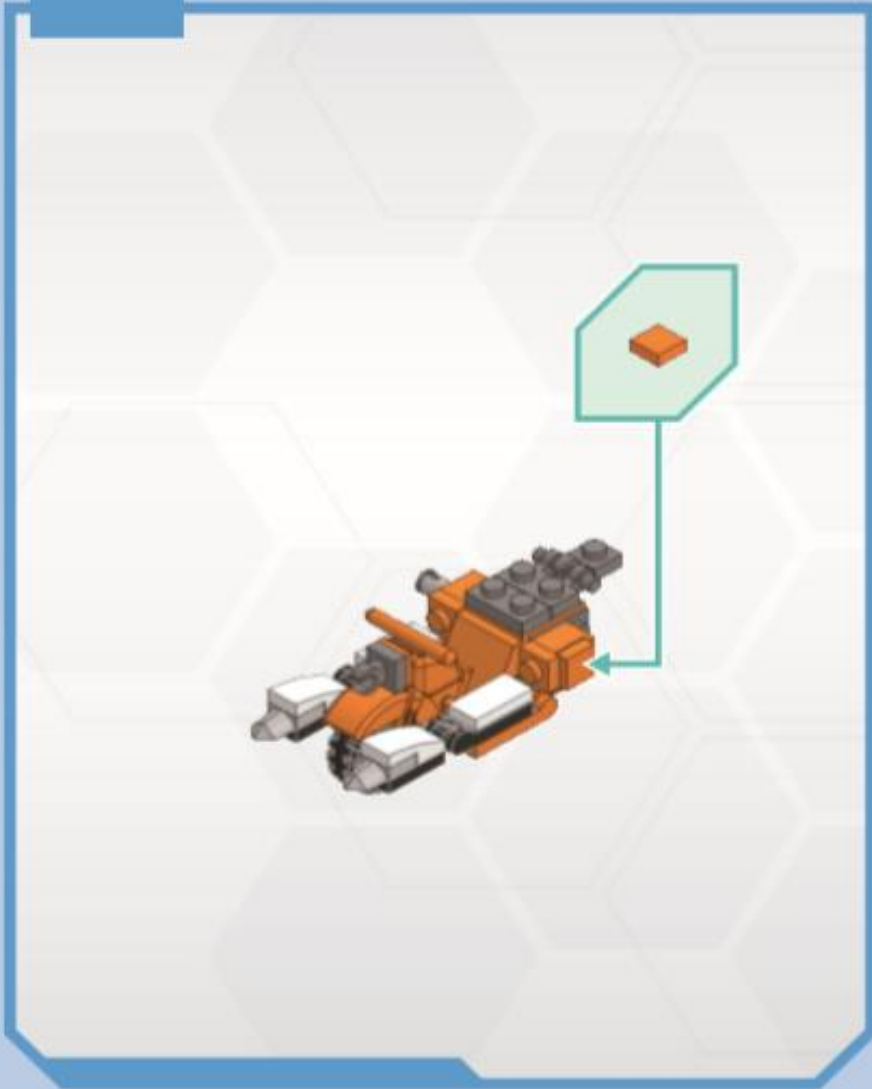
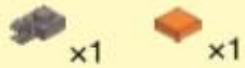

31



14

32

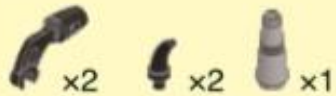

33

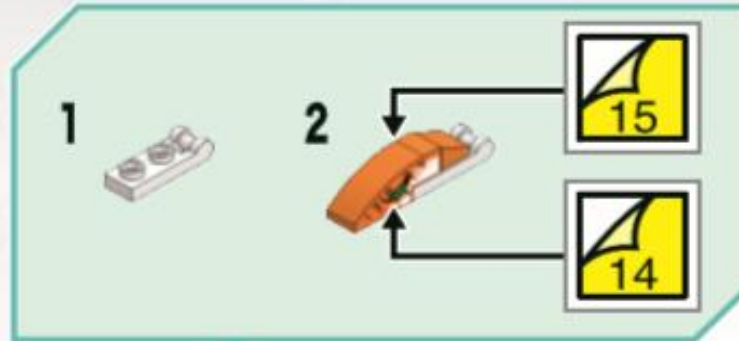

15

組立番号33で完成したサイドカー（ライドラプター）を、  
組立番号23のバイク本体（レンジャーバイク）に取り付けてください



**完成！ダイノスピードラー**



ここからは遊び方の説明です  
サイドカー（ライドラプター）を  
バイクモードからダイノモードに  
変形させます



↑ 本体（レンジャーバイク）から、  
サイドカー（ライドラプター）  
を取り外したら、上図のように  
変形させてください